

# RETAIL PRICE LIST

EFFECTIVE APRIL 2022

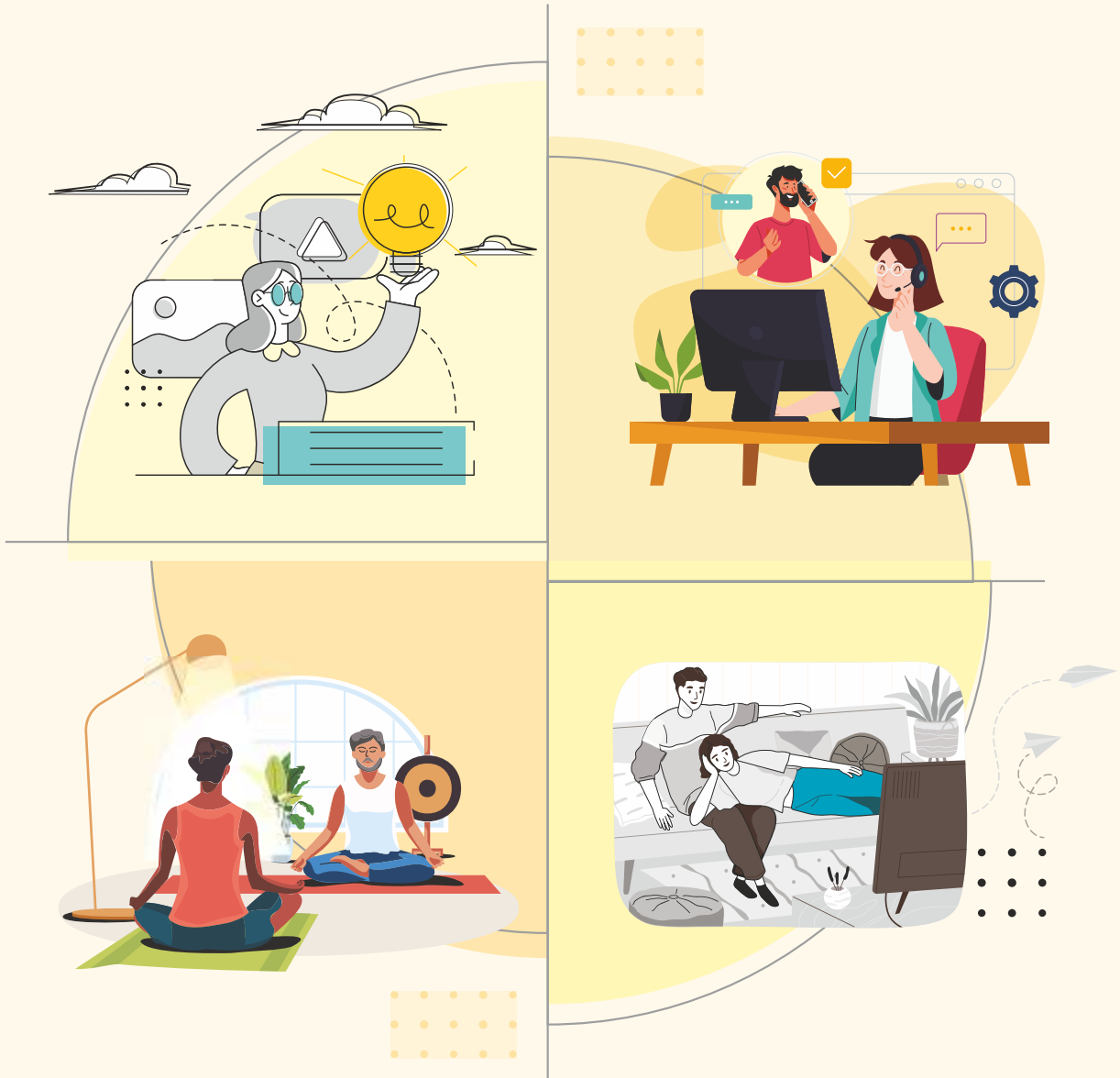

**MINIATURE  
CIRCUIT BREAKER**



**DISTRIBUTION  
BOARD**



**MOULDED CASE  
CIRCUIT BREAKER**



**AUTOMATIC  
CHANGEOVER WITH  
CURRENT LIMITER**



**WIRING DEVICES**



**Caretron™ MINIATURE CIRCUIT BREAKER - MCB**

- ISI / CE Marked as per IS/IEC 60898 -1 • Degree of Protection IP 20 • 25 sq. mm Terminals • Breaking Capacity 6kA
- Bi-Connect Terminals • Positive Isolation • Frequency 50Hz • Operating Voltage 240V / 415V AC, 60V DC per Pole

**B CURVE SINGLE POLE**

**HSN Code: 8536**

	Rating (A)	Pack	Cat. Nos.	Unit Price (₹)
	6	1/12/180	810000	202
10	1/12/180	810001	202	
16	1/12/180	810002	202	
20	1/12/180	810003	202	
25	1/12/180	810004	202	
32	1/12/180	810005	202	
40	1/12/180	810006	446	
50	1/12/180	810007	502	
63	1/12/180	810008	502	

**B CURVE SINGLE POLE NEUTRAL**

**HSN Code: 8536**

	Rating (A)	Pack	Cat. Nos.	Unit Price (₹)
	6	1/6/90	810009	674
10	1/6/90	810010	674	
16	1/6/90	810011	674	
20	1/6/90	810012	674	
25	1/6/90	810013	674	
32	1/6/90	810014	674	
40	1/6/90	810015	974	
50	1/6/90	810016	1076	
63	1/6/90	810017	1076	

**B CURVE DOUBLE POLE**

**HSN Code: 8536**

	Rating (A)	Pack	Cat. Nos.	Unit Price (₹)
	6	1/6/90	810018	710
10	1/6/90	810019	710	
16	1/6/90	810020	710	
20	1/6/90	810021	710	
25	1/6/90	810022	710	
32	1/6/90	810023	710	
40	1/6/90	810024	1030	
50	1/6/90	810025	1154	
63	1/6/90	810026	1154	

**C CURVE SINGLE POLE**

**HSN Code: 8536**

	Rating (A)	Pack	Cat. Nos.	Unit Price (₹)
	6	1/12/180	810054	204
10	1/12/180	810055	204	
16	1/12/180	810056	204	
20	1/12/180	810057	204	
25	1/12/180	810058	204	
32	1/12/180	810059	204	
40	1/12/180	810060	462	
50	1/12/180	810061	538	
63	1/12/180	810062	538	

**Caretron™ MINIATURE CIRCUIT BREAKER - MCB**

- ISI / CE Marked as per IS/IEC 60898 - 1 • Degree of Protection IP 20 • 25 sq. mm Terminals • Breaking Capacity 6kA
- Bi-Connect Terminals • Positive Isolation • Frequency 50Hz • Operating Voltage 240V / 415V AC, 60V DC per Pole

**C CURVE SINGLE POLE NEUTRAL**

**HSN Code: 8536**

	Rating (A)	Pack	Cat. Nos.	Unit Price (₹)
	6	1/6/90	810063	750
10	1/6/90	810064	750	
16	1/6/90	810065	750	
20	1/6/90	810066	750	
25	1/6/90	810067	750	
32	1/6/90	810068	750	
40	1/6/90	810069	1040	
50	1/6/90	810070	1228	
63	1/6/90	810071	1228	

**C CURVE DOUBLE POLE**

**HSN Code: 8536**

	Rating (A)	Pack	Cat. Nos.	Unit Price (₹)
	6	1/6/90	810072	758
10	1/6/90	810073	758	
16	1/6/90	810074	758	
20	1/6/90	810075	758	
25	1/6/90	810076	758	
32	1/6/90	810077	758	
40	1/6/90	810078	1108	
50	1/6/90	810079	1248	
63	1/6/90	810080	1248	

**C CURVE THREE POLE**

**HSN Code: 8536**

	Rating (A)	Pack	Cat. Nos.	Unit Price (₹)
	6	1/4/60	810081	1246
10	1/4/60	810082	1246	
16	1/4/60	810083	1246	
20	1/4/60	810084	1246	
25	1/4/60	810085	1246	
32	1/4/60	810086	1246	
40	1/4/60	810087	1754	
50	1/4/60	810088	1930	
63	1/4/60	810089	1930	

**C CURVE THREE POLE NEUTRAL**

**HSN Code: 8536**

	Rating (A)	Pack	Cat. Nos.	Unit Price (₹)
	6	1/3/45	810090	1644
10	1/3/45	810091	1644	
16	1/3/45	810092	1644	
20	1/3/45	810093	1644	
25	1/3/45	810094	1644	
32	1/3/45	810095	1644	
40	1/3/45	810096	2178	
50	1/3/45	810097	2374	
63	1/3/45	810098	2374	

**Caretron™ MINIATURE CIRCUIT BREAKER - MCB**

**C CURVE FOUR POLE**

**HSN Code: 8536**

	Rating (A)	Pack	Cat. Nos.	Unit Price (₹)
	6	1/3/45	810099	1660
10	1/3/45	810100	1660	
16	1/3/45	810101	1660	
20	1/3/45	810102	1660	
25	1/3/45	810103	1660	
32	1/3/45	810104	1660	
40	1/3/45	810105	2202	
50	1/3/45	810106	2412	
63	1/3/45	810107	2412	

**Caretron™ ISOLATOR**

- Conforms to IEC 60947-3 • Bi-Connect Terminals • Positive Isolation
- Degree of Protection IP 20 • 25 sq. mm Terminals

**DOUBLE POLE**

**HSN Code: 8536**

	Rating (A)	Pack	Cat. Nos.	Unit Price (₹)
	40	1/6/90	810130	504
63	1/6/90	810131	622	

**THREE POLE**

**HSN Code: 8536**

	Rating (A)	Pack	Cat. Nos.	Unit Price (₹)
	40	1/4/60	810132	902
63	1/4/60	810133	1016	

**FOUR POLE**

**HSN Code: 8536**

	Rating (A)	Pack	Cat. Nos.	Unit Price (₹)
	40	1/3/45	810134	1120
63	1/3/45	810135	1174	

**Caretron™ RESIDUAL CURRENT CIRCUIT BREAKER - RCCB**

- ISI/CE marked as per IS/IEC12640 • Rated Conditional Short Circuit Current, ICC6kA
- Degree of Protection IP 20 • Bi-Connect Terminals • 25 sq. mm Terminals

**DOUBLE POLE**

**HSN Code: 8536**

	Rating (A)	Sensitivity	Pack	Cat. Nos.	Unit Price (₹)
	25	30 mA	1/6/90	810150	2768
25	100 mA	1/6/90	810153	2858	
25	300 mA	1/6/90	810156	2858	
40	30 mA	1/6/90	810151	3066	
40	100 mA	1/6/90	810154	3114	
40	300 mA	1/6/90	810157	3114	
63	30 mA	1/6/90	810152	3904	
63	100 mA	1/6/90	810155	3946	
63	300 mA	1/6/90	810158	3946	

**FOUR POLE**

**HSN Code: 8536**

	Rating (A)	Sensitivity	Pack	Cat. Nos.	Unit Price (₹)
	25	30 mA	1/3/45	810159	3624
25	100 mA	1/3/45	810162	3668	
25	300 mA	1/3/45	810165	3668	
40	30 mA	1/3/45	810160	3700	
40	100 mA	1/3/45	810163	3766	
40	300 mA	1/3/45	810166	3766	
63	30 mA	1/3/45	810161	4112	
63	100 mA	1/3/45	810164	4174	
63	300 mA	1/3/45	810167	4174	

—optipro— **MINIATURE CIRCUIT BREAKER - MCB**

- ISI / CE Marked as per IS/IEC 60898 - 1 • Rated Short-Circuit Breaking Capacity, Icn 10kA • Degree of Protection IP 20
- Energy Limitation Class 3 • Line Load Reversibility • 35 sq. mm Terminals • Biconnect Terminals • Frequency: 50 Hz
- Operating Voltage : 240V/415V AC , 60V DC per pole

**B CURVE SINGLE POLE**

**HSN Code: 8536**

	Rating (A)	Pack	Cat. Nos.	Unit Price (₹)
	6	1/12/180	811008	250
10	1/12/180	811010	250	
16	1/12/180	811012	250	
20	1/12/180	811013	250	
25	1/12/180	811014	250	
32	1/12/180	811015	250	
40	1/12/180	811016	566	
50	1/12/180	811017	660	
63	1/12/180	811018	660	

**B CURVE SINGLE POLE NEUTRAL**

**HSN Code: 8536**

	Rating (A)	Pack	Cat. Nos.	Unit Price (₹)
	6	1/6/90	811027	844
10	1/6/90	811029	844	
16	1/6/90	811031	844	
20	1/6/90	811032	844	
25	1/6/90	811033	844	
32	1/6/90	811034	844	
40	1/6/90	811035	1184	
50	1/6/90	811036	1340	
63	1/6/90	811037	1340	

**B CURVE DOUBLE POLE**

**HSN Code: 8536**

	Rating (A)	Pack	Cat. Nos.	Unit Price (₹)
	6	1/6/90	811046	878
10	1/6/90	811048	878	
16	1/6/90	811050	878	
20	1/6/90	811051	878	
25	1/6/90	811052	878	
32	1/6/90	811053	878	
40	1/6/90	811054	1264	
50	1/6/90	811055	1408	
63	1/6/90	811056	1408	

—optipro— **ISOLATOR**

- Conforms to IEC 60947-3 • CE Marked • Degree of Protection IP 20 • 35 sq. mm Terminals • Biconnect Terminals
- Frequency: 50 Hz • Operating Voltage: 240V/415V AC, 60V DC per Pole

**DOUBLE POLE**

**HSN Code: 8536**

	Rating (A)	Pack	Cat. Nos.	Unit Price (₹)
	80	1/6/90	811552	884
100	1/6/90	811553	884	
125	1/6/90	811554	952	

**THREE POLE**

**HSN Code: 8536**

	Rating (A)	Pack	Cat. Nos.	Unit Price (₹)
	80	1/4/60	811557	1338
100	1/4/60	811558	1338	
125	1/4/60	811559	1466	

**FOUR POLE**

**HSN Code: 8536**

	Rating (A)	Pack	Cat. Nos.	Unit Price (₹)
	80	1/3/45	811562	1660
100	1/3/45	811563	1660	
125	1/3/45	811564	1796	

**AUTOMATIC CHANGEOVER WITH CURRENT LIMITER**

- As per IEC60947-6-1
- Intelligent micro controller based Design
- RoHS Compliant

**HSN Code: 8536**

	Rating (A)	Pack	Cat. Nos.	Unit Price (₹)
	SPN 30A Mains 1.5A DG ACCL	1/3/45	810409	1970
	SPN 30A Mains 2.5A DG ACCL	1/3/45	810410	1970
	SPN 30A Mains 3A DG ACCL	1/3/45	810400	1970
	SPN 30A Mains 4A DG ACCL	1/3/45	810401	1970
	SPN 30A Mains 5A DG ACCL	1/3/45	810402	1970
	SPN 30A Mains 6A DG ACCL	1/3/45	810403	1970
	SPN 30A Mains 9A DG ACCL	1/3/45	810404	1970
	SPN 30A Mains 12A DG ACCL	1/3/45	810405	1970
	SPN 30A Mains 15A DG ACCL	1/3/45	810406	1970
	SPN 30A Mains 20A DG ACCL	1/3/45	810407	1970
	SPN 30A Mains 30A DG ACCL	1/3/45	810408	1970



# RELIABILITY - SAFETY - ALL ROUND PROTECTION



Innovative design



Detachable Gland Plate



Degree of protection  
IP30 and IP 42

**Caretron**™  
Made for India



**Caretron™ DISTRIBUTION BOARDS**

- Innovative Design • Degree of Protection IP 30 & IP 42 • Detachable Gland Plate • Attractive Pearl Shade
- Box Insertion Marks • Circuit Identification Label • Neutral Link • Earth Link • Tin Plated Copper Bus Bar

**SPN SINGLE DOOR**

**HSN Code: 8537**

	No. of Way	Incomer+ Outgoing	Pack	Cat. Nos.	Unit Price (₹)
	4	4	1/19	810311	860
	6	6	1/18	810312	946
	8	8	1/13	810313	1076
	12	12	1/11	810315	1470
	16	16	1/9	810316	1798

**SPN DOUBLE DOOR**

**HSN Code: 8537**

	No. of Way	Incomer+ Outgoing	Pack	Cat. Nos.	Unit Price (₹)
	4	4	1/14	810319	1494
	6	6	1/12	810320	1666
	8	8	1/10	810321	1858
	12	12	1/9	810323	2298
	16	16	1/7	810324	2820

**HSN Code: 8537**

**SPN ACRYLIC**

	No. of Way	Incomer+ Outgoing	Pack	Cat. Nos.	Unit Price (₹)
	4	4	1/12	810345	1048
	6	6	1/12	810346	1212
	8	8	1/8	810347	1426
	10	10	1/8	810348	1580
	12	12	1/8	810349	1756
16	16	1/6	810350	2712	

**TPN SINGLE DOOR**

**HSN Code: 8537**

	No. of Way	Incomer+ Outgoing	Pack	Cat. Nos.	Unit Price (₹)
	4	4 + 12	1/8	810327	2608
	4	8 + 12	1/8	810328	2936
	6	4 + 18	1/5	810329	3136
	6	8 + 18	1/5	810330	3670
	8	8 + 24	1/4	810331	4188
	12	8 + 36	1/4	810332	5644

**TPN DOUBLE DOOR**

**HSN Code: 8537**

	No. of Way	Incomer+ Outgoing	Pack	Cat. Nos.	Unit Price (₹)
	4	4 + 12	1/6	810336	3646
	4	8 + 12	1/6	810337	3788
	6	4 + 18	1/4	810338	4240
	6	8 + 18	1/4	810339	4522
	8	8 + 24	1/3	810340	5578
	12	8 + 36	1/3	810341	6320

**Caretron™ DISTRIBUTION BOARDS**

- Innovative Design • Degree of Protection IP 30 & IP 42 • Detachable Gland Plate • Attractive Pearl Shade
- Box Insertion Marks • Circuit Identification Label • Neutral Link • Earth Link • Tin Plated Copper Bus Bar

**VTPN MCB INCOMER SINGLE DOOR**

**HSN Code: 8537**

	No. of Way	Incomer+ Outgoing	Pack	Cat. Nos.	Unit Price (₹)
	4	8 + 12	1	810353	7284
	6	8 + 18	1	810354	8802
	8	8 + 24	1	810355	10060
	12	8 + 36	1	810356	11550

**VTPN MCB INCOMER DOUBLE DOOR**

**HSN Code: 8537**

	No. of Way	Incomer+ Outgoing	Pack	Cat. Nos.	Unit Price (₹)
	4	8 + 12	1	810359	9400
	6	8 + 18	1	810360	11014
	8	8 + 24	1	810361	12270
	12	8 + 36	1	810362	16216

**VTPN 125A MCCB I/C DD DB**

**HSN Code: 8537**

	No. of Way	Incomer+ Outgoing	Pack	Cat. Nos.	Unit Price (₹)
	4	Optium F1 + 12	1	810436	10580
	6	Optium F1 + 18	1	810437	11618
	8	Optium F1 + 24	1	810438	12222
	12	Optium F1 + 36	1	810439	15310

**VTPN 250A MCCB I/C DD DB**

**HSN Code: 8537**

	No. of Way	Incomer+ Outgoing	Pack	Cat. Nos.	Unit Price (₹)
	4	Optium F2 + 12	1	810446	13226
	6	Optium F2 + 18	1	810447	14530
	8	Optium F2 + 24	1	810448	15280
	12	Optium F2 + 36	1	810449	19146

**PHASE SELECTOR BARE SINGLE DOOR**

**HSN Code: 8537**

	No. of Way	Incomer+ Outgoing	Pack	Cat. Nos.	Unit Price (₹)
	4	8 + 12	1	810365	6776
	6	8 + 18	1	810366	7138
	8	8 + 24	1	810367	7250
	12	8 + 36	1	810368	9484

**PHASE SELECTOR BARE DOUBLE DOOR**

**HSN Code: 8537**

	No. of Way	Incomer+ Outgoing	Pack	Cat. Nos.	Unit Price (₹)
	4	8 + 12	1	810371	8540
	6	8 + 18	1	810372	8986
	8	8 + 24	1	810373	9596
	12	8 + 36	1	810374	10730

**PHASE SELECTOR 40A DOUBLE DOOR (PRE FITTED SELECTOR SWITCHES)**

**HSN Code: 8536**

	No. of Way	Incomer+ Outgoing	Pack	Cat. Nos.	Unit Price (₹)
	4	8 + 12	1	810375	10466
	6	8 + 18	1	810376	11372
	8	8 + 24	1	810377	11928
	12	8 + 36	1	810378	13638

**PHASE SELECTOR 63A DOUBLE DOOR (PRE FITTED SELECTOR SWITCHES)**

**HSN Code: 8536**

	No. of Way	Incomer+ Outgoing	Pack	Cat. Nos.	Unit Price (₹)
	4	8 + 12	1	810379	12464
	6	8 + 18	1	810380	13514
	8	8 + 24	1	810381	14114
	12	8 + 36	1	810382	15938

**PLUG & SOCKET BOX**

**HSN Code: 8536**

	No. of Way	Incomer+ Outgoing	Pack	Cat. Nos.	Unit Price (₹)
	20A SP (with 20A SP 'C' MCB)	1	1/24	810393	1080
	20A DP (with 20A DP 'C' MCB)	2	1/24	810394	1440
	20A TP	3	1/8	810309	2344
	32A TP	3	1/8	810310	3262

**METAL ENCLOSURE**

**HSN Code: 8537**

	No. of Way	Incomer+ Outgoing	Pack	Cat. Nos.	Unit Price (₹)
	1	1	1/60	810302	426
	2	2	1/36	810303	426
	3	3	1/36	810304	500
	4	4	1/32	810305	500

**PLASTIC ENCLOSURE**

**HSN Code: 8536**

	No. of Way	Incomer+ Outgoing	Pack	Cat. Nos.	Unit Price (₹)
	1 & 2	1/2	1/5/45	810300	102
	3 & 4	3/4	1/3/27	810301	158

**BUSBAR CHAMBER  
TPN BBC (Cu-Busbar)**

**HSN Code: 8536**

	<p>Solution for safe Power Distribution</p> <ul style="list-style-type: none"> <li>• Step type design</li> <li>• Available in both SPN &amp; TPN configuration</li> </ul>	Item Description	Ingress Protection*	Cat Ref.	Unit Price* (₹)
		Spl. 32A TPN BBC (Cu) with 4 o/g ways	IP42	CPPI1015	7324
		Spl. 63A TPN BBC (Cu) with 4 o/g ways	IP42	CPPI1016	8170
		Spl. 100A TPN BBC (Cu) with 4 o/g ways	IP42	CPPI1017	9050
		Spl. 200A TPN BBC (Cu) with 4 o/g ways	IP42	CPPI1018	11194
		Spl. 250A TPN BBC (Cu) with 4 o/g ways	IP42	CPPI1019	15934
		Spl. 320A TPN BBC (Cu) with 4 o/g ways	IP42	CPPI1020	19358
		Spl. 400A TPN BBC (Cu) with 4 o/g ways	IP42	CPPI1021	21508
		Spl. 630A TPN BBC (Cu) with 4 o/g ways	IP42	CPPI1022	34410

\*Also available in IP54 design

**BUSBAR CHAMBER  
TPN-Type (Al.Busbar)**

**HSN Code: 8536**

	<p>Solution for safe Power Distribution</p> <ul style="list-style-type: none"> <li>• Step type design</li> <li>• Available in both SPN &amp; TPN configuration</li> </ul>	Item Description	Ingress Protection*	Cat Ref.	Unit Price* (₹)
		Spl. 32A TPN BBC (Al.) with 4 o/g ways	IP42	CPPI1023	6884
		Spl. 63A TPN BBC (Al.) with 4 o/g ways	IP42	CPPI1024	7324
		Spl. 100A TPN BBC (Al.) with 4 o/g ways	IP42	CPPI1025	7728
		Spl. 200A TPN BBC (Al.) with 4 o/g ways	IP42	CPPI1026	8170
		Spl. 250A TPN BBC (Al.) with 4 o/g ways	IP42	CPPI1027	9874
		Spl. 320A TPN BBC (Al.) with 4 o/g ways	IP42	CPPI1028	10754
		Spl. 400A TPN BBC (Al.) with 4 o/g ways	IP42	CPPI1029	11194
		Spl. 630A TPN BBC (Al.) with 4 o/g ways	IP42	CPPI1008	19240

\*Also available in IP54 design

**MCCB ENCLOSURE**

**HSN Code: 8537**

- Solid Neutral Link for 3 Pole MCCBs

	Description	Pack	Cat. Nos.	Unit Price (₹)
	Optipro Enclosure for Frame-1 Optium 3 Pole MCCB	1	811984	1820
	Optipro Enclosure for Frame-1 Optium 4 Pole MCCB	1	811985	1820
	Optipro Enclosure for Frame-2 Optium 3 Pole MCCB	1	811986	2820
	Optipro Enclosure for Frame-2 Optium 4 Pole MCCB	1	811987	2820
	Optipro Enclosure for Frame-3 Optium 3 Pole MCCB	1	811988	2820
	Optipro Enclosure for Frame-3 Optium 4 Pole MCCB	1	811989	2820
	Optipro Enclosure for Frame-4 Optium 3 Pole MCCB	1	811990	7020
	Optipro Enclosure for Frame-4 Optium 4 Pole MCCB	1	811991	7020

**METAL CLAD PLUG & SOCKET  
AC PLUG**

**HSN Code: 8536**

	Rating	Pack	Cat. Nos.	Unit Price (₹)
	10A 2P+E, 230V AC	1/10/100	810385	170
	20A 2P+E, 230V AC	1/10/100	810386	182
	20A 3P+E, 230V / 415V AC	1/10/100	810387	246
	32A 3P+E, 230V / 415V AC	1/10/100	810388	446

**AC SOCKET**

**HSN Code: 8536**

	Rating	Pack	Cat. Nos.	Unit Price (₹)
	10A 2P+E, 230V AC	1/10/100	810389	170
	20A 2P+E, 230V AC	1/10/100	810390	194
	20A 3P+E, 230V / 415V AC	1/10/100	810391	258
	32A 3P+E, 230V / 415V AC	1/10/100	810392	446

**TIME SWITCHES**

**HSN Code: 9107**

	Model Name	Description	Cat Ref.	Unit Price (₹)
	1mod DIN Daily	1P Module, 24 hours program, Programmable every 15 min., backup of 100 hours, current capacity 16A, with 1 changeover (1 CO)	TA916422	3612
	3mod DIN Daily	3P Module, 24 hours program, Programmable every 15 min., backup of 100 hrs., current capacity 16A, with 1 changeover (1 CO)	TA926453	3934
	DIN Type Daily / Weekly with 1 CO	Programmable every 1 min., with backup of 6 years, 28 memory locations, current capacity 16A, weekly program, with 1 changeover (1 CO), Total 28 program	TDA43110	4780

\* For other models of Time Switches please contact nearest Branch Office.

—optium™— **OPTIUM 1.0E (FIXED TM MCCB RANGE)**

- Ics =50% Icu as per IEC 60947-II
- Suitable for isolation
- Class II front face
- Fixed Overload & fixed short circuit setting

**HSN Code: 8536**

	Frame	Breaking capacity	Rating	3P	Unit Price (₹)	4P	Unit Price (₹)
	F1	10kA	16	830701	2562	830710	3110
	F1	10kA	25	830702	2562	830711	3110
	F1	10kA	32	830703	2562	830712	3110
	F1	10kA	40	830704	2562	830713	3110
	F1	10kA	50	830705	2562	830714	3110
	F1	10kA	63	830706	2562	830715	3110
	F1	10kA	80	830707	2886	830716	3694
	F1	10kA	100	830708	2886	830717	3694
	F1	10kA	125	830709	4136	830718	5344

**HSN Code: 8536**

	Frame	Breaking capacity	Rating	3P	Unit Price (₹)	4P	Unit Price (₹)
	F1	16kA	16	830001	4266	830015	5210
	F1	16kA	25	830002	4266	830016	5210
	F1	16kA	32	830003	4266	830017	5210
	F1	16kA	40	830004	4266	830018	5210
	F1	16kA	50	830005	4266	830019	5210
	F1	16kA	63	830006	4266	830020	5210
	F1	16kA	80	830007	4478	830021	5768
	F1	16kA	100	830008	4478	830022	5768
	F1	16kA	125	830009	6206	830023	8158

**HSN Code: 8536**

	Frame	Breaking capacity	Rating	3P	Unit Price (₹)	4P	Unit Price (₹)
	F1	25kA	16	830031	5134	830045	6136
	F1	25kA	25	830032	5134	830046	6136
	F1	25kA	32	830033	5134	830047	6136
	F1	25kA	40	830034	5134	830048	6136
	F1	25kA	50	830035	5134	830049	6136
	F1	25kA	63	830036	5134	830050	6136
	F1	25kA	80	830037	5286	830051	6442
	F1	25kA	100	830038	5286	830052	6442
	F1	25kA	125	830039	6366	830053	8474

**HSN Code: 8536**

	Frame	Breaking capacity	Rating	3P	Unit Price (₹)	4P	Unit Price (₹)
	F1	36kA	16	830061	6796	830075	7774
	F1	36kA	25	830062	6796	830076	7774
	F1	36kA	32	830063	6796	830077	7774
	F1	36kA	40	830064	6796	830078	7774
	F1	36kA	50	830065	6796	830079	7774
	F1	36kA	63	830066	6796	830080	7774
	F1	36kA	80	830067	6900	830081	8192
	F1	36kA	100	830068	6900	830082	8192
	F1	36kA	125	830069	9508	830083	9882

—optium™— **OPTIUM 1.0 (FIXED TM MCCB RANGE)**

**HSN Code: 8536**

	Frame	Breaking capacity	Rating	3P	Unit Price (₹)	4P	Unit Price (₹)
	F3	50kA	16	830125	8208	830145	9978
	F3	50kA	25	830126	8208	830146	9978
	F3	50kA	32	830127	8208	830147	9978
	F3	50kA	40	830128	8208	830148	9978
	F3	50kA	50	830129	8208	830149	9978
	F3	50kA	63	830130	8208	830150	9978
	F3	50kA	80	830131	8622	830151	10280
	F3	50kA	100	830132	8622	830152	10280
	F3	50kA	125	830133	10058	830153	12754

**HSN Code: 8536**

	Frame	Breaking capacity	Rating	3P	Unit Price (₹)	4P	Unit Price (₹)
	F2	16kA	160	830090	6724	830095	9708
	F2	16kA	200	830091	8662	830096	11276
	F2	16kA	250	830092	9558	830097	11910
	F2	25kA	160	830100	7922	830105	9964
	F2	25kA	200	830101	10956	830106	13254
	F2	25kA	250	830102	14136	830107	16618
	F2	36kA	160	830110	9976	830115	12226
	F2	36kA	200	830111	12778	830116	16146
F2	36kA	250	830112	16680	830117	21936	

**HSN Code: 8536**

	Frame	Breaking capacity	Rating	3P	Unit Price (₹)	4P	Unit Price (₹)
	F3	50kA	160	830134	11252	830154	15450
	F3	50kA	200	830135	13542	830155	19012
F3	50kA	250	830136	17418	830156	23138	

**HSN Code: 8536**

	Frame	Breaking capacity	Rating	3P	Unit Price (₹)	4P	Unit Price (₹)
	F4	36kA	315	830165	22742	830175	25946
	F4	36kA	400	830166	24036	830176	27420
	F4	36kA	500	830167	26896	830177	31124
F4	36kA	630	830168	28508	830178	32760	

**HSN Code: 8536**

	Frame	Breaking capacity	Rating	3P	Unit Price (₹)	4P	Unit Price (₹)
	F4	50kA	315	830185	23410	830195	27756
	F4	50kA	400	830186	25550	830196	29980
	F4	50kA	500	830187	27780	830197	32222
F4	50kA	630	830188	29448	830198	33388	

**HSN Code: 8536**

	Frame	Breaking capacity	Rating	3P	MRP	4P	MRP
F5	50kA	800	830200	37998	830201	49082	

—optium™— **OPTIUM 1.1 (FIXED TM MCCB RANGE)**

- Ics = 100% Icu as per IEC 60947-II
- Suitable for isolation
- Class II front face
- Fixed Overload & fixed short circuit setting

**HSN Code: 8536**

**NEW**

Frame	Breaking capacity	Rating	3P	Unit Price (₹)	4P	Unit Price (₹)
F1	16kA	32	840003	4440	840017	5826
F1	16kA	40	840004	4440	840018	5826
F1	16kA	63	840006	4440	840020	5826
F1	16kA	80	840007	4614	840021	6232
F1	16kA	100	840008	4614	840022	6232
F1	16kA	125	840009	6472	840023	8698
F1	25kA	32	840033	5386	840047	6824
F1	25kA	40	840034	5386	840048	6824
F1	25kA	63	840036	5386	840050	6824
F1	25kA	80	840037	5708	840051	6956
F1	25kA	100	840038	5708	840052	6956
F1	25kA	125	840039	6604	840053	9758
F2	16kA	160	840090	7074	840095	10546
F2	16kA	200	840091	8880	840096	11788
F2	16kA	250	840092	10122	840097	13512
F2	25kA	160	840100	8234	840105	10880
F2	25kA	200	840101	11218	840106	13884
F2	25kA	250	840102	14936	840107	18122

—optium™— **OPTIUM 2.0 (ADJUSTABLE THERMAL SETTING MCCB)**

- Conforms to IEC 60947-II
- Adjustable Overload Setting  $I_r = (0.8 \text{ to } 1.0) \times I_n$
- Ics = 100% Icu
- Class II front face
- Short Circuit setting fixed
- Suitable for isolation

**HSN Code: 8536**

Frame	Breaking capacity	Rating	3P	Unit Price (₹)	4P	Unit Price (₹)
F1	16kA	25	830222	4518	830236	6032
F1	16kA	32	830223	4518	830237	6032
F1	16kA	40	830224	4518	830238	6032
F1	16kA	50	830225	4518	830239	6032
F1	16kA	63	830226	4518	830240	6032
F1	16kA	80	830227	4898	830241	6486
F1	16kA	100	830228	4898	830242	6486
F1	16kA	125	830229	6686	830243	9038

**HSN Code: 8536**

Frame	Breaking capacity	Rating	3P	Unit Price (₹)	4P	Unit Price (₹)
F1	25kA	25	830252	5666	830266	7132
F1	25kA	32	830253	5666	830267	7132
F1	25kA	40	830254	5666	830268	7132
F1	25kA	50	830255	5666	830269	7132
F1	25kA	63	830256	5666	830270	7132
F1	25kA	80	830257	5944	830271	7482
F1	25kA	100	830258	5944	830272	7482
F1	25kA	125	830259	6878	830273	10238

**HSN Code: 8536**

Frame	Breaking capacity	Rating	3P	Unit Price (₹)	4P	Unit Price (₹)
F2	16kA	160	830280	7420	830285	10924
F2	16kA	200	830281	9246	830286	12240
F2	16kA	250	830282	10702	830287	14462
F2	25kA	160	830290	9390	830295	12320
F2	25kA	200	830291	12020	830296	15508
F2	25kA	250	830292	16070	830297	20096

—optium™— **OPTIUM 2.0 (ADJUSTABLE TM MCCB RANGE)**

- Ics =100% Icu as per IEC 60947-II
- Adjustable Overload Setting Ir =(0.8 to 1.0)×In
- Class II front face
- Adjustable Short Circuit Setting I<sub>sd</sub> =(5 -10)×In
- Suitable for isolation

**HSN Code: 8536**

	Frame	Breaking capacity	Rating	3P		4P	
				Unit Price (₹)	4P	Unit Price (₹)	4P
	F3	36kA	16	830305	7652	830325	10574
	F3	36kA	25	830306	7652	830326	10574
	F3	36kA	32	830307	7652	830327	10574
	F3	36kA	40	830308	7652	830328	10574
	F3	36kA	50	830309	7652	830329	10574
	F3	36kA	63	830310	7652	830330	10574
	F3	36kA	80	830311	7802	830331	10884
	F3	36kA	100	830312	7802	830332	10884
	F3	36kA	125	830313	10018	830333	12194

**HSN Code: 8536**

	Frame	Breaking capacity	Rating	3P		4P	
				Unit Price (₹)	4P	Unit Price (₹)	4P
	F3	50kA	16	830345	10302	830365	12314
	F3	50kA	25	830346	10302	830366	12314
	F3	50kA	32	830347	10302	830367	12314
	F3	50kA	40	830348	10302	830368	12314
	F3	50kA	50	830349	10302	830369	12314
	F3	50kA	63	830350	10302	830370	12314
	F3	50kA	80	830351	10510	830371	12436
	F3	50kA	100	830352	10510	830372	12436
	F3	50kA	125	830353	11564	830373	14846

**HSN Code: 8536**

	Frame	Breaking capacity	Rating	3P		4P	
				Unit Price (₹)	4P	Unit Price (₹)	4P
	F3	36kA	160	830314	12782	830334	15210
	F3	36kA	200	830315	14334	830335	19846
	F3	36kA	250	830316	18828	830336	25990

**HSN Code: 8536**

	Frame	Breaking capacity	Rating	3P		4P	
				Unit Price (₹)	4P	Unit Price (₹)	4P
	F3	50kA	160	830354	13248	830374	16708
	F3	50kA	200	830355	15456	830375	21190
	F3	50kA	250	830356	21938	830376	27372

**HSN Code: 8536**

	Frame	Breaking capacity	Rating	3P		4P	
				Unit Price (₹)	4P	Unit Price (₹)	4P
	F4	25kA	315	830385	20022	830387	25216
	F4	25kA	400	830386	20500	830388	27510
	F4	36kA	315	830390	24060	830395	29304
	F4	36kA	400	830391	25596	830396	31552
	F4	36kA	500	830392	29834	830397	36990
	F4	36kA	630	830393	32412	830398	41434
	F4	50kA	315	830400	25690	830405	31732
	F4	50kA	400	830401	27420	830406	33322
	F4	50kA	500	830402	31408	830407	39068
	F4	50kA	630	830403	33956	830408	43342



—optium™— **OPTIUM 2.0 (ADJUSTABLE TM MCCB RANGE)**

**HSN Code: 8536**

	Frame	Breaking capacity	Rating	3P	Unit Price (₹)	4P	Unit Price (₹)
	F5	36kA	800	830410	39216	830413	48088
	F5	36kA	1000	830411	56478	830414	64604
	F5	36kA	1250	830412	65322	830415	77632
	F5	50kA	800	830416	40372	830419	57520
	F5	50kA	1000	830417	70212	830420	75292
	F5	50kA	1250	830418	77438	830421	87208

—optium™— **ACCESSORIES**

**HSN Code: 8538**

	Product	Frame	Cat Ref.	Unit Price (₹)
	Auxiliary contact	F1 F2 F3	830691	1038
	Alarm Contact	F1 F2 F3	830692	1038
	Auxiliary contact / Alarm Contact	F4-F5	830693	1362
	Auxiliary contact / Alarm Contact	F1 F2 F3	830694	1556

**HSN Code: 8538**

	Product	Frame	Cat Ref.	Unit Price (₹)
	"Shunt trip 24 V AC/DC"	F1 F2 F3	830602	1176
	"Shunt trip 110 V AC/DC"	F1 F2 F3	830603	1176
	"Shunt trip 230 V AC/DC"	F1 F2 F3	830604	1258
	"Shunt trip 415 V AC/DC"	F1 F2 F3	830605	1258
	"Shunt trip 24 V AC/DC"	F4 F5	830642	2312
	"Shunt trip 110 V AC/DC"	F4 F5	830643	2312
	"Shunt trip 230 V AC/DC"	F4 F5	830644	2312
	"Shunt trip 415 V AC/DC"	F4 F5	830645	2312

**HSN Code: 8538**

	Product	Frame	Cat Ref.	Unit Price (₹)
	"Undervoltage 24 V DC"	F1 F2 F3	830606	1928
	"Undervoltage 110V AC"	F1 F2 F3	830607	1928
	"Undervoltage 230V AC"	F1 F2 F3	830608	1928
	"Undervoltage 415V AC"	F1 F2 F3	830609	1928
	"Undervoltage 24 V DC"	F4 F5	830646	2054
	"Undervoltage 110V AC"	F4 F5	830647	2054
	"Undervoltage 230V AC"	F4 F5	830648	2054
	"Undervoltage 415V AC"	F4 F5	830649	2054

**HSN Code: 8538**

	Product	Frame	Cat Ref.	Unit Price (₹)
	Rotary Handle Direct	F1	830611	1476
	Rotary Handle vary-Depth	F1	830612	1476
	Rotary Handle Direct	F2 F3	830626	1734
	Rotary Handle vary-Depth	F2 F3	830627	1734
	Rotary Handle Direct	F4	830651	2054
	Rotary Handle vary-Depth	F4	830652	2054
	Rotary Handle Direct	F5	830671	4024
	Rotary Handle vary-Depth	F5	830672	4024

—optium™— **ACCESSORIES**

**HSN Code: 8538**



Product	Frame	Cat Ref.	Unit Price (₹)
Ronis lock Direct RH	F1 F2 F3	830613	1618
Ronis lock Vary-Depth RH	F1 F2 F3	830614	1618
Ronis lock Vary-Depth RH	F4	830653	2182

**HSN Code: 8538**



Product	Frame	Cat Ref.	Unit Price (₹)
Padlock Off position	F1 F2 F3	830615	2204
Padlock Off position	F4	830654	2204
Padlock Off position	F5	830674	2204

**HSN Code: 8538**



Product	Frame	Cat Ref.	Unit Price (₹)
Phase insulators 3P	F1 F2	830616	POR
Phase insulators 3P	F3	830628	POR
Phase insulators 3P	F4	830655	POR
Phase insulators 3P	F5	830675	POR
Phase insulators 4P	F1 F2	830617	POR
Phase insulators 4P	F3	830629	POR
Phase insulators 4P	F4	830656	POR
Phase insulators 4P	F5	830676	POR

**HSN Code: 8538**

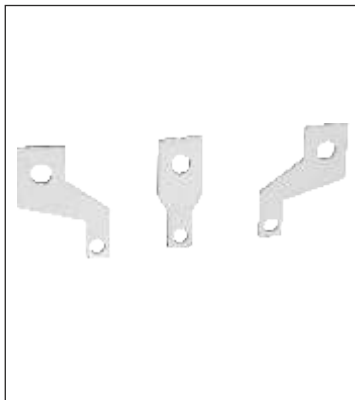

Product	Frame	Cat Ref.	Unit Price (₹)
Spreaders 3P	F1	830618	398
Spreaders 4P	F1	830619	580
Spreaders 3P	F2 F3	830632	1058
Spreaders 4P	F2 F3	830633	2116
Spreaders 3P	F4	830659	3386
Spreaders 4P	F4	830660	4938
Spreaders 3P 800/1000A	F5	830681	8746
Spreaders 4P 800/1000A	F5	830682	12824
Spreaders 3P 1250A	F5	830685	9096
Spreaders 4P 1250A	F5	830686	13408

**HRC FUSE LINKS & BASES**

**BOLTED TYPE (BS) BREAKING CAPACITY ≥ 80kA 500 V AC 50 Hz.**

**HSN Code: 8536**

	Rating	Type	Cat Ref.	Tag Type	Unit Price (₹)	Unit/Carton
		2, 4, 6, 8, 10, 16A	FGN	IEFGN***	Offset	88
	20, 25, 32A	FGN	IEFGN***	Offset	98	20
	2, 4, 6, 10, 16, 20, 25, 32A	FSA	IEFSA***	Offset	132	10
	35, 40, 50, 63A	FSS	IEFSS***	Offset	148	10
	50, 63, 80, 100, 125, 160A	FSDCP	IEDCP***	Offset	314	10
	100, 125, 160, 200, 250A	FSFP	IESFP***	Offset	452	3
	50, 63, 80, 100, 125A	FSDC	IESDC***	Central	314	10
	100, 125, 160, 200, 250A	FSF	IEFSF***	Central	462	3
	225, 250, 300, 315, 320A	FSK	IEFSK***	Central	668	3
	355, 400A	FMF	IEFMF***	Central	1290	3
	355, 400, 450, 500, 560, 600, 630A	FTS	IEFTS***	Central	1488	1
	355, 400, 450, 500, 560A	FTM	IEFTM***	2 Central	1920	1
	600, 630A	FTM	IEFTM***	2 Central	2640	1

**DIN TYPE BREAKING CAPACITY ≥ 80kA 500 V AC 50 Hz.**

**HSN Code: 8536**

	Rating Amps	Type	Cat Ref.	Unit Price (₹)	Unit/Carton
		2, 4, 6, 10, 16, 20, 25, 32, 50, 63A	Size 000	IWS00***	394
	2, 4, 6, 10, 16, 20, 25, 32, 36, 40, 50, 63A	Size 00	IW000***	418	6
	80, 100A		IW000***	436	6
	125, 160A		IW000***	464	6
	32, 36, 50, 63, 80, 100, 125, 160, 200A	Size 01	IW001***	766	3
	250A		IW001***	872	3
	100, 125, 160, 200, 250, 315A	Size 02	IW002***	1124	3
	400A		IW002***	1216	3
	315, 355, 400, 425A	Size 03	IW003***	1544	3
	500, 630A		IW003***	1796	3

\* Note HRC fuses with SC breaking capacity 120kA are available on request.

**CYLINDRICAL TYPE (IFRH) BREAKING CAPACITY > 80kA 415 V AC.**

**HSN Code: 8536**

	Rating	Cat Ref.	Unit Price (₹)
		2 to 25A	IFRHO***
	32 to 40A	IFRHO***	174
	50A	IFRH0050	322
	63A	IFRH0063	332
	Fuse Holder Fr type (2 to 63A)	IFR00***	310

**FUSE FITTINGS FOR BOLTED (BS) TYPE**

**HSN Code: 8536**

	Rating	Front Connection	Unit Price (₹)	Back Busbar Connection	Unit Price (₹)	Unit/Carton
		20A	BFFC 0020	188	BFBC 0020	202
	32A	BFFC 0032	330	BFBC 0032	342	10
	63A	BFFC 0063	474	BFBC 0063	500	5
	100A	BFFC 0100	1220	BFBC 0100	1156	3
	20A (Stud Type)			BFFCS 020	272	1



**FUSE BASES FOR DIN TYPE HRC FUSE LINKS**

**HSN Code: 8536**

	Rating Amps	Suitable for	Cat Ref.	Unit Price (₹)	Unit/Carton
		6-160A	Size - 00	IWFB0***	538
	32-250A	Size - 1	IWFB1***	1026	2
	100-400A	Size - 2	IWFB2***	1532	2
	315-630A	Size - 3	IWFB3***	1944	2



**SWITCH DISCONNECTOR FUSES**

**HSN Code: 8536**

Rated Current	Type	IN OPEN EXECUTION*		IN SHEET STEEL ENCLOSURE		Recommended HRC Fuse Indo Asian Make	
		Cat Ref.	Unit Price (₹)	Cat Ref.	Unit Price (₹)		
	32A BS	TPN	INO1A032	1952	INS1A032	3982	FSA
	63A BS	TPN	INO1A063	2700	INS1A063	5074	FSS
	100A BS	TPN	INO1A100	5936	INS1A100	8304	FSDCP
	125A BS	TPN	INO1A125	6660	INS1A125	9952	FSDCP
	160A BS	TPN	INO1A160	8062	INS1A160	11112	FSDCP
	200A BS	TPN	INO1A200	10030	INS1A200	12926	FSF
	250A BS	TPN	INO1A250	11324	INS1A250	14944	FSF
	315A BS	TPN	INO1A315	14510	INS1A315	18660	FSK
	400A BS	TPN	INO1A400	18010	INS1A400	22274	FMF
	32A BS	TPSN	INO1B032	2480	INS1B032	4200	FSA
	63A BS	TPSN	INO1B063	3150	INS1B063	4970	FSS
	100A BS	TPSN	INO1B100	7298	INS1B100	9298	FSDCP
	125A BS	TPSN	INO1B125	7992	INS1B125	9952	FSDCP
	160A BS	TPSN	INO1B160	9996	INS1B160	12862	FSDCP
	200A BS	TPSN	INO1B200	11386	INS1B200	14230	FSF
	250A BS	TPSN	INO1B250	12414	INS1B250	15978	FSF
	315A BS	TPSN	INO1B315	17566	INS1B315	22320	FSK
	400A BS	TPSN	INO1B400	20780	INS1B400	23216	FMF

\* Price Does Not Include HRC Fuse

**HSN Code: 8536**

Rated Current	Type	IN OPEN EXECUTION*		IN SHEET STEEL ENCLOSURE		Recommended HRC Fuse Indo Asian Make	
		Cat Ref.	Unit Price (₹)	Cat Ref.	Unit Price (₹)		
	32A DIN	TPN	IN10A032	2050	IN1SA032	3790	Size 000
	63A DIN	TPN	IN10A063	2844	IN1SA063	4818	Size 000
	100A DIN	TPN	IN10A100	6084	IN1SA100	8212	Size 00
	125A DIN	TPN	IN10A125	6952	IN1SA125	9924	Size 00
	160A DIN	TPN	IN10A160	8366	IN1SA160	10902	Size 00
	200A DIN	TPN	IN10A200	10444	IN1SA200	12408	Size 01
	250A DIN	TPN	IN10A250	11700	IN1SA250	14936	Size 01
	315A DIN	TPN	IN10A315	15030	IN1SA315	18592	Size 02
	400A DIN	TPN	IN10A400	18528	IN1SA400	22038	Size 02
	630A DIN	TPN	IN10A630	29184	IN1SA630	31430	Size 03
	800A DIN	TPN	IN10A800	35584	IN1SA800	44492	Size 03
	32A DIN	TPSN	IN10B032	2906	IN1SB032	3900	Size 000
	63A DIN	TPSN	IN10B063	3350	IN1SB063	4212	Size 000
	100A DIN	TPSN	IN10B100	7506	IN1SB100	8400	Size 00
	125A DIN	TPSN	IN10B125	8318	IN1SB125	9042	Size 00
	160A DIN	TPSN	IN10B160	9746	IN1SB160	12090	Size 00
	200A DIN	TPSN	IN10B200	11326	IN1SB200	12752	Size 01
	250A DIN	TPSN	IN10B250	12972	IN1SB250	14610	Size 01
	315A DIN	TPSN	IN10B315	17362	IN1SB315	19880	Size 02
	400A DIN	TPSN	IN10B400	20176	IN1SB400	24824	Size 02
	630A DIN	TPSN	IN10B630	32392	IN1SB630	33954	Size 03
	800A DIN	TPSN	IN10B800	37454	IN1SB800	48940	Size 03

\* Price Does Not Include HRC Fuse

**SWITCH DISCONNECTOR 4 POLE**

**HSN Code: 8536**

Rated Current	IN OPEN EXECUTION*		IN SHEET STEEL ENCLOSURE	
	Cat Ref.	Unit Price (₹)	Cat Ref.	Unit Price (₹)
32A	IN1SD032	2048	IN1ED032	3912
63A	IN1SD063	3168	IN1ED063	4622
100A	IN1SD100	4912	IN1ED100	8398
125A	IN1SD125	6402	IN1ED125	9530
160A	IN1SD160	8022	IN1ED160	11168
200A	IN1SD200	8934	IN2ED200	13816
250A	IN1SD250	11576	IN2ED250	18226
315A	IN1SD315	12582	IN3ED315	19922
400A	IN1SD400	14766	IN3ED400	23356
630A	IN1SD630	20492	IN4ED630	34074
800A	IN1SD800	24406	IN4ED800	39468

\*Prices of 3 Pole SD is available on Request.

**Ambidex CHANGEOVER SWITCHES  
ON-LOAD CHANGEOVER SWITCHES 4 POLE**

**HSN Code: 8536**

Rated Current	IN OPEN EXECUTION		IN SHEET STEEL ENCLOSURE	
	Cat Ref.	Unit Price (₹)	Cat Ref.	Unit Price (₹)
63A	ITAE0063	5622	ITAS0063	8808
100A	ITAE0100	7462	ITAS0100	11190
125A	ICAE0125	11180	ICAS0125	16764
160A	ICAE0160	12296	ICAS0160	18438
200A	ICAE0200	14784	ICAS0200	21472
250A	ICAE0250	21166	ICAS0250	28548
320A	ICAE0320	22414	ICAS0320	30774
400A	ICAE0400	32526	ICAS0400	51096
630A	ICAE0630	38318	ICAS0630	54754
800A	ITAE0800	53438	ITAS0800	80214
1000A	ITAE1000	96670	ITAS1000	134436
1250A	ITAE1250	129738	ITAS1250	185598
1600A	ITAE1600	148972	ITAS1600	246264
2000A	ITAE2000	217848	ITAS2000	301958
2500A	ITAE2500	299712	ITAS2500	400528
3150A	ITAE3150	306537	ITAS3150	519950

**HSN Code: 8536**

ACCESSORIES FOR AMBIDEX CHANGEOVER SWITCHES	Cat Ref.	Unit Price (₹)
Auxiliary Switch 200A-630A (1NO + 1NC)	ICA00AUX	224
Spreader Links for Frame00 - 1 set (4 links)	ICA00SPL	350

**ON-LOAD SWITCH FUSE CHANGEOVER**

**HSN Code: 8536**

Rated Current	IN OPEN EXECUTION		IN SHEET STEEL ENCLOSURE		Recommended HRC Fuse Indo Asian Make
	Cat Ref.	Unit Price (₹)	Cat Ref.	Unit Price (₹)	
125A	ITBE0125	15242	ITBS0125	23294	FSDCP
200A	ITBE0200	27848	ITBS0200	41346	FSF
250A	ITBE0250	28110	ITBS0250	41730	FSK
320A	ITBE0320	29022	ITBS0320	43088	FSK
400A	ITBE0400	41628	ITBS0400	61802	FTS
630A	ITBE0630	48582	ITBS0630	72132	FTS

Price does not include HRC Fuses.

**HSN Code: 8536**

**ON-LOAD BY-PASS SWITCHES**

Rated Current	IN OPEN EXECUTION		IN SHEET STEEL ENCLOSURE	
	Cat Ref.	Unit Price (₹)	Cat Ref.	Unit Price (₹)
125A	ITCE0125	21370	ITCS0125	28854
200A	ITCE0200	27212	ITCS0200	36736
250A	ITCE0250	39530	ITCS0250	53366
320A	ITCE0320	41046	ITCS0320	55414
400A	ITCE0400	61568	ITCS0400	83120
630A	ITCE0630	69948	ITCS0630	94434

**REWIRABLE SWITCH FUSE UNIT**

**HSN Code: 8537**

 <ul style="list-style-type: none"> <li>• Single Pole &amp; Neutral/Double Pole 240/415 VAC 50 Hz</li> <li>• Conforms to IS/IEC 13947-3</li> </ul>	Rating	Type	Cat Ref.	Rated Voltage	Unit Price* (₹)
	16A	SPN	RCSPN016	240 V	816
	32A	SPN	RCSPN032	240 V	1964
	16A	DP	RCDP0016	240 V	860
	32A	DP	RCDP0032	240 V	2018
	32A	DP	#DDP0032	415 V	2774
	63A	DP	#DDP0063	415 V	5202

# For Rewirable type carrier, prefix R, for HRC type carrier, prefix H.  
\* These prices are without wire & HRC.

**COMBINATION FUSE SWITCH**

**HSN Code: 8536**

 <ul style="list-style-type: none"> <li>• Double Break in Sheet steel enclosure</li> <li>• Conforms to IS/IEC 13947-3</li> <li>• Rated Voltage - 415V AC 50 Hz</li> <li>• Type - TPN</li> </ul>	Rating	HRC Fuse Type	Cat Ref.	Unit Price* (₹)
	63A	FSS	DDTPN063	9854
	100A	FSDCP	DDTPN100	13232
	200A	FSF	DDTPN200	19696
	300A	FSK	DDTPN300	24848
	400A	FTS	DDTPN400	36044

\* These prices are without HRC.

**TRIPLE POLE NEUTRAL HRC TYPE  
REWIRABLE SWITCH FUSE UNIT**

**HSN Code: 8537 H**  
**HSN Code: 8536 R**

 <ul style="list-style-type: none"> <li>• Rated Voltage - 415V-AC 50Hz</li> <li>• Type - TPN</li> </ul>	Rating	HRC Fuse Type	Cat Ref.	Unit Price* (₹)
	16A	FSA	#DTPN016	2378
	32A	FSA	#DTPN032	3200
	63A	FSS	#DTPN063	6810
	100A	FSDCP	#DTPN100	12422

# For Rewirable type carrier, prefix R, for HRC type carrier, prefix H.  
\* These prices are without wire & HRC.

**OFF LOAD CHANGEOVER SWITCH**

**HSN Code: 8536**

 <ul style="list-style-type: none"> <li>• With enclosure</li> <li>• Rated Voltage - 415V-AC 50Hz</li> <li>• Type - FP</li> </ul>	Rating	Cat Ref.	Unit Price (₹)
	32A (DP)	OFDP0032	1936
	16A	OFFP0016	3100
	32A	OFFP0032	3236
	63A	OFFP0063	6576
	100A	OFFP0100	12854
	125A	OFFP0125	18070
	200A	OFFP0200	19508
	250A	OFFP0250	24852
	315A	OFFP0315	25656
	400A	OFFP0400	29930

Prices for spares of Rewirable Switch Fuse Unit like Action Bar, Base Plate, End Shield, Bakelite Contact Shrouds are available on request.



\*Available in single plate and double plate

## GIVE YOUR WALLS AN EXPERIENCE OF GLINT



Honeycomb Effect



Comes with both wooden & metal screws



USB charger with 1 & 2 Module



Range from 1M to 18M

ISI marked 6A socket

**Glint**<sup>™</sup>  
Welcome Change

**Glint™ SWITCH / SWITCH WITH INDICATOR**

• Polycarbonate Material • LED Indicator • ISI Marked

HSN Code: 8536

Description	Module	Pack	Cat. Nos.	Unit Price (₹)	
				Module	Pack
6A 1-way Switch	1	1/20/400	800000		32
6A 2-way Switch	1	1/20/200	800001		66
16A 1-way Switch	1	1/20/200	800002		90
16A 2-way Switch	1	1/10/100	800003		114
16A 1-way Switch with indicator	1	1/10/100	800004		110
20A DP Switch	2	1/10/50	800005		134
32A DP Switch	2	1/10/50	800006		200
6A Bell Push with Indicator-1M	1	1/10/100	800007		78
6A Bell Push with Indicator-2M	2	1/10/100	800008		116

**Glint™ SOCKET / TELEPHONE SOCKET / COMPUTER SOCKET / TV SOCKET**

HSN Code: 8536

• Pencil Free Operation • Child Safety Shutter • Accommodate Wide Range of 2 Pin Round and Flat Pin Plugs • \*ISI mark

Description	Module	Pack	Cat. Nos.	Unit Price (₹)	
				Module	Pack
6A 3 Pin Universal Socket	2	1/20/200	800020		66
10A Euro US Socket	1	1/20/100	800021		58
6/16A 3 Pin Socket*	2	1/10/100	800022		124
6A 3 Pin Socket*	2	1/10/100	801800		82
Multistandard Socket 6/10/13A-250V, 15A-127V	2	1/10/100	800023		118
Telephone Socket - RJ11	1	1/20/100	800030		70
Computer Socket- RJ45	1	1/20/100	800031		162
TV Socket	1	1/20/100	800032		64

**Glint™ USB CHARGER**

Modular charging socket to charge your Mobile , Tested as per IS standard

HSN Code: 8536

Description	Module	Pack	Cat. Nos.	Unit Price (₹)	
				Module	Pack
USB Charger	2	5/50	800019		954
USB Charger 1.5A	1	10/100	800044		714

**Glint™ BUZZER / POWER UNIT / INDICATOR**

HSN Code: 8536

• Power Unit - Prewired, Suitable for 2 Ton Ac / 3.5 kw Geyser

Description	Module	Pack	Cat. Nos.	Unit Price (₹)	
				Module	Pack
Buzzer - 230V	1	1/20/100	800040		174
16A Power Unit for AC & Geyser	4	1/1/5	800025		308
Flat Indicator Red	1	1/10/100	800033		88

**Glint™ FAN STEP REGULATOR**

HSN Code: 8414

• Fan Marking for Easy Identification

Description	Module	Pack	Cat. Nos.	Unit Price (₹)	
				Module	Pack
Fan Step Regulator - 100W	1	1/10/100	800041		304
Fan Step Regulator - 100W - 2M	2	1/10/100	800043		342

**Glint™ LIGHT DIMMER**

HSN Code: 8538

• Marking for Easy Identification

Description	Module	Pack	Cat. Nos.	Unit Price (₹)	
				Module	Pack
Light Dimmer - 400W	1	1/10/100	800042		296



**Glint™ MINI MCB**

HSN Code: 8536

- Marking for Easy Identification

	Description	Module	Pack	Cat. Nos.	Unit Price (₹)
	MINI MCB SP 16A	1	1/10/100	800010	288
	MINI MCB SP 20A	1	1/10/100	800011	288
	MINI MCB SP 25A	1	1/10/100	800012	288
	MINI MCB SP 32A	1	1/10/100	800013	288

**Glint™ BLANK PLATE / SCREW CAPS**

HSN Code: 8538

- Spare Screw Caps Available

	Description	Module	Pack	Cat. Nos.	Unit Price (₹)
	1 Module Blank Plate	1	1/20/200	800051	20
	2 Module Blank Plate	2	1/10/100	800052	24
	Screw Caps	-	1/10/100	800059	20*

\* One Unit Contains Ten Pieces of Screw Caps

**Glint™ MODULAR PLATES - WHITE COLOUR**

- Unique Design - Sleek & Curvy • Flame Retardant Material • Compatible with Standard Size of Metal Flush & Plastic Surface Boxes

HSN Code: 8538

	Description	Module	Pack	Cat. Nos.	Unit Price (₹)
	1 Module Plate	1	1/10/100	800061	46
	2 Module Plate	2	1/10/100	800062	46
	3 Module Plate	3	1/10/100	800063	66
	4 Module Plate	4	1/10/100	800064	78
	6 Module Plate	6	1/5/50	800066	96
	8 Module Plate (Vertical)	8	1/5/25	800067	136
	8 Module Plate (Horizontal)	8	1/5/50	800068	128
	12 Module Plate	12	1/5/25	800065	174
	16 Module Plate	16	1/5/25	800069	182
	18 Module Plate	18	1/5/25	800070	220

**Glint™ MODULAR DOUBLE PLATES - WHITE COLOUR**

- Aesthetic Design • Suitable for Metal Flush & Wooden Boxes
- Comes with both Metal & Wooden Screws

HSN Code: 8538

	Description	Module	Pack	Cat. Nos.	Unit Price (₹)
	Double Plate + Frame 1M	1	1/10/100	800071	70
	Double Plate + Frame 2M	2	1/10/100	800072	70
	Double Plate + Frame 3M	3	1/10/100	800073	90
	Double Plate + Frame 4M	4	1/10/100	800074	110
	Double Plate + Frame 6M	6	1/10/50	800076	140
	Double Plate + Frame 8M (Vertical)	8	1/5/25	800078	198
	Double Plate + Frame 8M (Horizontal)	8	1/10/50	800079	198
	Double Plate + Frame 10M	10	1/5/25	800080	232
	Double Plate + Frame 12M (Vertical)	12	1/5/25	800082	252
	Double Plate + Frame 12M (Horizontal)	12	1/5/25	800084	252
	Double Plate + Frame 16M	16	1/5/25	800086	288
	Double Plate + Frame 18M	18	1/5/25	800088	314

**Glint™ METAL FLUSH BOX**

• Made of G.I. Sheet • Earth Terminal for Safety

**HSN Code: 8538**

	Description	Module	Pack	Cat. Nos.	Unit Price (₹)
	Metal Flush Box - 1 / 2 Module	1 / 2	1/0/40	800172	62
	Metal Flush Box - 3 Module	3	1/0/40	800173	82
	Metal Flush Box - 4 Module	4	1/0/40	800174	96
	Metal Flush Box - 6 Module	6	1/0/20	800176	144
	Metal Flush Box - 8 Module(V)	8	1/0/20	800177	188
	Metal Flush Box - 8 Module(H)	8	1/0/20	800178	188
	Metal Flush Box - 12 Module	12	1/0/10	800175	248
	Metal Flush Box - 16 Module	16	1/0/10	800179	284
	Metal Flush Box - 18 Module	18	1/0/10	800180	310

**Glint™ SURFACE BOX**

• Flame Retardant Material • Edge to Edge Fitting with Glint Plate

**HSN Code: 8538**

	Description	Module	Pack	Cat. Nos.	Unit Price (₹)
	Plastic Surface Box 1/2 Module	1 / 2	1/0/50	800182	66
	Plastic Surface Box - 3 Module	3	1/0/35	800183	84
	Plastic Surface Box - 4 Module	4	1/0/25	800184	96
	Plastic Surface Box - 6 Module	6	1/0/10	800186	148
	Plastic Surface Box - 8 Module (V)	8	1/0/15	800187	200
	Plastic Surface Box - 8 Module (H)	8	1/0/10	800188	200
	Plastic Surface Box - 12 Module	12	1/0/10	800185	252
	Plastic Surface Box - 16 Module	16	1/0/10	800189	294
	Plastic Surface Box - 18 Module	18	1/0/10	800190	320

**Cover Plates - Glint™**

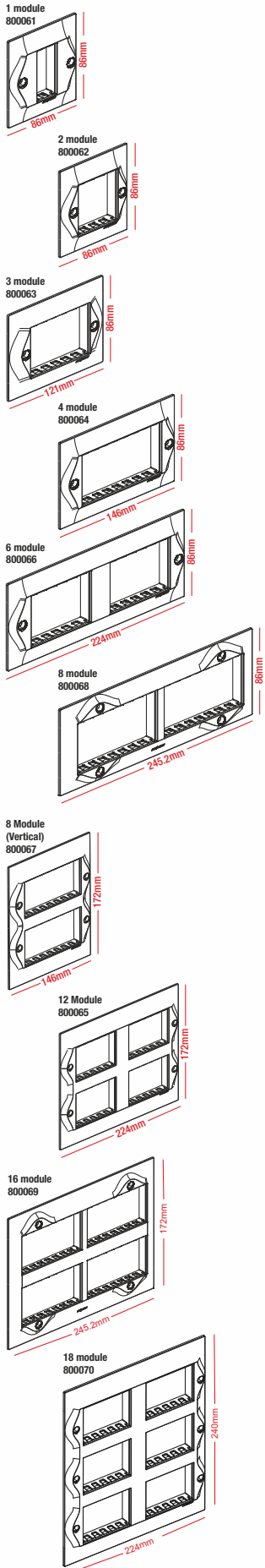

**Flush Boxes-Metal**

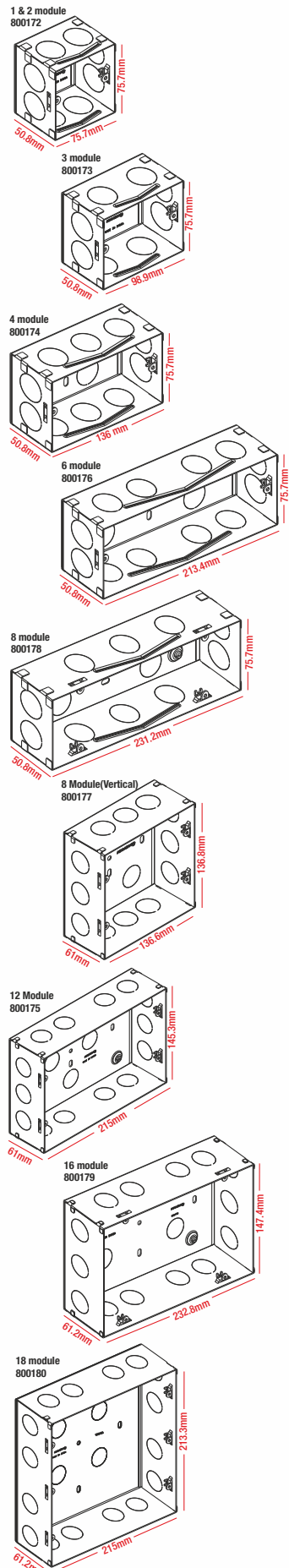

**Surface Boxes**

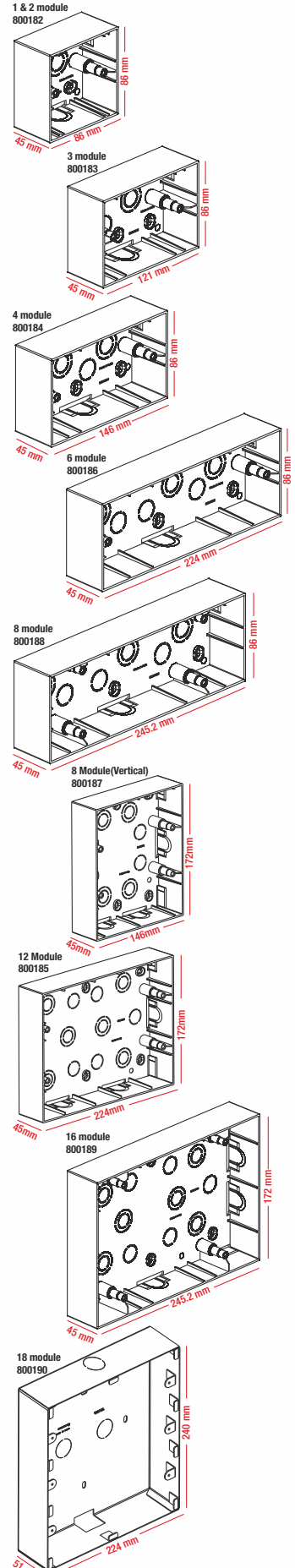



\* tested in a controlled environment

#TurnOnYourStyleSense

## COLOURS THAT REFLECT YOUR PERSONALITY



All four colour



Trending colours



Contemporary finishes



More resistant to scratches & Fading\*

**ELVIRA**  
A SENSIBLE SWITCH

ISI marked 6A socket

**ELVIRA SWITCH / SWITCH WITH INDICATOR**  
A SENSIBLE SWITCH

• Polycarbonate Material • LED Based Indicator • Shrouded Terminal • ISI Marked

HSN Code: 8536

	Description	Module	Pack	Cat. Nos.	Unit Price (₹)
	6A 1 way Switch	1	1/20/400	800100	36
6A 2 way Switch	1	1/20/100	800101	84	
6A 1 way Switch with indicator	1	1/20/200	800102	82	
16A 1 way Switch	1	1/20/200	800103	102	
16A 2 way Switch	1	1/10/100	800104	140	
16A 1way Switch with indicator	1	1/20/200	800105	124	
25A 1 way Switch with indicator	1	1/10/100	800106	182	
20A DP Switch	2	1/10/50	800107	176	
32A DP Switch	2	1/10/50	800108	244	
6A Bell Push with indicator - 1M	1	1/20/200	800110	90	
6A Bell Push with indicator - 2M	2	1/10/100	800111	140	

**ELVIRA SOCKET**  
A SENSIBLE SWITCH

• Child Safety Shutter • Shrouded Terminals • Compatible with all standard Mobile chargers • \*ISI mark

HSN Code: 8536

	Description	Module	Pack	Cat. Nos.	Unit Price (₹)
	6A 3 Pin Universal Socket	2	1/20/200	800120	92
10A Euro US Socket	1	1/20/100	800121	78	
6/16A 3 Pin Socket*	2	1/10/50	800122	166	
6A 3 Pin Socket*	2	1/10/50	802800	88	
25A 3 Pin Socket	2	1/10/50	800124	192	
Multistandard Socket 6/10/13A-250v	2	1/10/100	800123	160	

**ELVIRA USB CHARGER**  
A SENSIBLE SWITCH

Modular charging socket to charge your Mobile , Tested as per IS standard

HSN Code: 8536

	Description	Module	Pack	Cat. Nos.	Unit Price (₹)
	USB Charger	1	10/100	800112	652
USB Charger 1.5A	1	10/100	800145	794	
USB Charger	2	5/50	800113	1180	

**ELVIRA RJ11 / RJ45 / TV SOCKET**  
A SENSIBLE SWITCH

Tool less, Twisted operation Computer Socket/RJ45

HSN Code: 8536

	Description	Module	Pack	Cat. Nos.	Unit Price (₹)
	Telephone Socket - RJ11	1	1/20/100	800130	90
Computer Socket - RJ45 Cat 6	1	1/20/100	800131	234	
TV Socket	1	1/20/100	800132	88	

**ELVIRA FAN REGULATOR**  
A SENSIBLE SWITCH

• Laser marking • ISI mark

HSN Code: 8414

	Description	Module	Pack	Cat. Nos.	Unit Price (₹)
	Fan Step Regulator 100W - 1M	1	1/10/100	800141	336
Fan Step Regulator 100W - 2M	2	1/10/100	800142	406	

**ELVIRA POWER UNIT / CONTROL PRODUCTS / MINI MCB**

A SENSIBLE SWITCH

• LED Indicator • Pre-Wired Power Unit

HSN Code: 8536

	Description	Module	Pack	Cat. Nos.	Unit Price (₹)
	Buzzer 230V	1	1/20/100	800140	246
	Power Unit with 16A AC & GYSR	3	1/1/5	800125	348
	Power Unit with 20A MCB & PLUG	3	1/1/5	800193	850
	Power Unit with 25A MCB & PLUG	3	1/1/5	800194	914
	Bell Call Indicator	1	1/20/100	800144	530
	Flat Indicator Red	1	1/20/100	800154	104
	Skirting light - 2M	2	1/5/25	800155	380
	25A Motor Starter	2	1/5/25	800196	404
	16A Mini MCB SP C curve	1	1/10/100	800160	360
	20A Mini MCB SP C curve	1	1/10/100	800191	360
	25A Mini MCB SP C curve	1	1/10/100	800156	360
32A Mini MCB SP C curve	1	1/10/100	800157	360	

**ELVIRA LIGHT DIMMER**

A SENSIBLE SWITCH

• Laser marking

HSN Code: 8538

	Description	Module	Pack	Cat. Nos.	Unit Price (₹)
	Light Dimmer 400W	1	1/10/100	800143	346

**ELVIRA HOTEL FUNCTION (KEY CARD AND DND)**

A SENSIBLE SWITCH

• LED Indicator

HSN Code: 8538

	Description	Module	Pack	Cat. Nos.	Unit Price (₹)
	DND Internal Unit	1	1/10/100	800192	174
	DND External Unit	1	1/10/100	800195	208
	Key Card SW 16A	2	1/10	800197	2028

**ELVIRA BLANK PLATES / CABLE OUTLET**

A SENSIBLE SWITCH

• Polycarbonate Material

HSN Code: 8538

	Description	Module	Pack	Cat. Nos.	Unit Price (₹)
	1 module Blank	1	1/20/200	800151	29
	2 module Blank	2	1/10/100	800152	40
	Cable outlet	1	1/20/100	800153	72

**ELVIRA MODULAR PLATE WITH SUPPORT FRAME - WHITE**

A SENSIBLE SWITCH

• Strong Dimensional Stability

HSN Code: 8538



	Description	Module	Pack	Cat. Nos.	Unit Price (₹)
	1 Module Plate	1	1/10/100	800161	70
	2 Module Plate	2	1/10/100	800162	70
	3 Module Plate	3	1/10/100	800163	92
	4 Module Plate	4	1/10/100	800164	102
	6 Module Plate	6	1/5/50	800166	136
	8 Module Plate (Horizontal)	8	1/5/50	800168	182
	8 Module Plate (Vertical)	8	1/5/25	800167	186
	12 Module Plate	12	1/5/25	800165	262
	16 Module Plate	16	1/5/25	800169	304
	18 Module Plate	18	1/5/25	800170	360

**ELVIRA MODULAR PLATE WITH SUPPORT FRAME - SILVER LIGHT PURPLE**

A SENSIBLE SWITCH

• Strong Dimensional Stability



HSN Code: 8538

 	Description	Module	Pack	Cat. Nos.	Unit Price (₹)
	Silver Light purple Plate 1M	1	1/10/100	800201	128
	Silver Light purple Plate 2M	2	1/10/100	800202	128
	Silver Light purple Plate 3M	3	1/10/100	800203	160
	Silver Light purple Plate 4M	4	1/10/100	800204	180
	Silver Light purple Plate 6M	6	1/5/50	800205	264
	Silver Light purple Plate 8M (Horizontal)	8	1/5/50	800206	282
	Silver Light purple Plate 8M (Vertical)	8	1/5/25	800207	342
	Silver Light purple Plate 12M	12	1/5/25	800208	488
	Silver Light purple Plate 16M	16	1/5/25	800209	664
Silver Light purple Plate 18M	18	1/5/25	800210	690	

**ELVIRA MODULAR PLATE WITH SUPPORT FRAME - INOX SILVER**

A SENSIBLE SWITCH



HSN Code: 8538

 	Description	Module	Pack	Cat. Nos.	Unit Price (₹)
	Inox Silver Plate 1M	1	1/10/100	800211	128
	Inox Silver Plate 2M	2	1/10/100	800212	128
	Inox Silver Plate 3M	3	1/10/100	800213	160
	Inox Silver Plate 4M	4	1/10/100	800214	180
	Inox Silver Plate 6M	6	1/5/50	800215	264
	Inox Silver Plate 8M (Horizontal)	8	1/5/50	800216	282
	Inox Silver Plate 8M (Vertical)	8	1/5/25	800217	342
	Inox Silver Plate 12M	12	1/5/25	800218	488
	Inox Silver Plate 16M	16	1/5/25	800219	664
Inox Silver Plate 18M	18	1/5/25	800220	690	

**ELVIRA MODULAR PLATE WITH SUPPORT FRAME - POLARISED GREY**

A SENSIBLE SWITCH



HSN Code: 8538

 	Description	Module	Pack	Cat. Nos.	Unit Price (₹)
	Polarised Grey Plate 1M	1	1/10/100	800221	128
	Polarised Grey Plate 2M	2	1/10/100	800222	128
	Polarised Grey Plate 3M	3	1/10/100	800223	160
	Polarised Grey Plate 4M	4	1/10/100	800224	180
	Polarised Grey Plate 6M	6	1/5/50	800225	264
	Polarised Grey Plate 8M (Horizontal)	8	1/5/50	800226	282
	Polarised Grey Plate 8M (Vertical)	8	1/5/25	800227	342
	Polarised Grey Plate 12M	12	1/5/25	800228	488
	Polarised Grey Plate 16M	16	1/5/25	800229	664
Polarised Grey Plate 18M	18	1/5/25	800230	690	

**ELVIRA MODULAR PLATE WITH SUPPORT FRAME - ASH PURPLE**

A SENSIBLE SWITCH

HSN Code: 8538

 	Description	Module	Pack	Cat. Nos.	Unit Price (₹)
	Ash Purple Plate 1M	1	1/10/100	800231	128
	Ash Purple Plate 2M	2	1/10/100	800232	128
	Ash Purple Plate 3M	3	1/10/100	800233	160
	Ash Purple Plate 4M	4	1/10/100	800234	180
	Ash Purple Plate 6M	6	1/5/50	800235	264
	Ash Purple Plate 8M (Horizontal)	8	1/5/50	800236	282
	Ash Purple Plate 8M (Vertical)	8	1/5/25	800237	342
	Ash Purple Plate 12M	12	1/5/25	800238	488
	Ash Purple Plate 16M	16	1/5/25	800239	664
Ash Purple Plate 18M	18	1/5/25	800240	690	

**ELVIRA METAL FLUSH BOX**  
A SENSIBLE SWITCH

• Made of G.I. Sheet • Earth Terminal for Safety

HSN Code: 8538

	Description	Module	Pack	Cat. Nos.	Unit Price (₹)
	Metal Flush Box - 1 / 2 Module	1 / 2	1/0/40	800172	62
	Metal Flush Box - 3 Module	3	1/0/40	800173	82
	Metal Flush Box - 4 Module	4	1/0/40	800174	96
	Metal Flush Box - 6 Module	6	1/0/20	800176	144
	Metal Flush Box - 8 Module(V)	8	1/0/20	800177	188
	Metal Flush Box - 8 Module(H)	8	1/0/20	800178	188
	Metal Flush Box - 12 Module	12	1/0/10	800175	248
	Metal Flush Box - 16 Module	16	1/0/10	800179	284
	Metal Flush Box - 18 Module	18	1/0/10	800180	310

**ELVIRA SURFACE BOX**  
A SENSIBLE SWITCH

• Flame Retardant Material • Edge to Edge Fitting with Plate

HSN Code: 8538

	Description	Module	Pack	Cat. Nos.	Unit Price (₹)
	Plastic Surface Box 1/2 Module	1 / 2	1/0/50	800182	66
	Plastic Surface Box - 3 Module	3	1/0/35	800183	84
	Plastic Surface Box - 4 Module	4	1/0/25	800184	96
	Plastic Surface Box - 6 Module	6	1/0/10	800186	148
	Plastic Surface Box - 8 Module (V)	8	1/0/15	800187	200
	Plastic Surface Box - 8 Module (H)	8	1/0/10	800188	200
	Plastic Surface Box - 12 Module	12	1/0/10	800185	252
	Plastic Surface Box - 16 Module	16	1/0/10	800189	294
	Plastic Surface Box - 18 Module	18	1/0/10	800190	320

**3 PIN PLUGS WITH EASY GRIP**

• White Matt Finish • Tested as per IS 1293

HSN Code: 8536

	Description	Pack	Cat. Nos.	Unit Price (₹)
	6A 3 Pin Plug	1/10/50	698470	78
	16A 3 Pin Plug	1/10/50	698471	114

**EXHAUST FAN**

• Copper Motor • RoHS Compliant • Rust Free Body

HSN Code: 8536

	Description	Pack	Cat. Nos.	Unit Price (₹)
	Exhaust Fan 150mm White	1/0/6	698500	1750
	Exhaust Fan 200mm White	1/0/6	698501	1950
	Exhaust Fan 250mm White	1/0/6	698501	2250





## ENCOURAGE HAPPY EXPERIMENT



RoHS  
Compliant



Low Power  
Consumption



Copper Motor

PRODUCT	150 mm	200 mm	250 mm
MRP (Per Unit)	1,750	1,950	2,250

**Zosta**<sup>TM</sup>  
The powerful Exhaust fan

**Cover Plates - ELVIRA**  
A SENSIBLE SWITCH

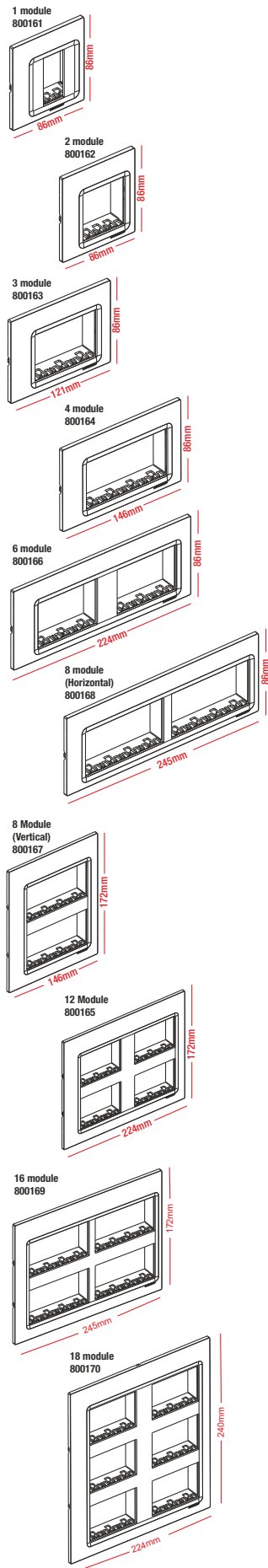

**Flush Boxes-Metal**

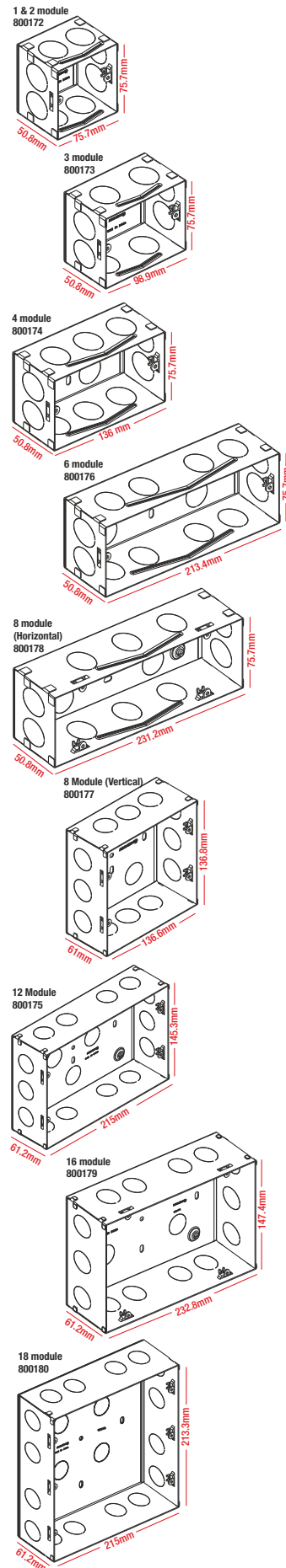

**Surface Boxes**

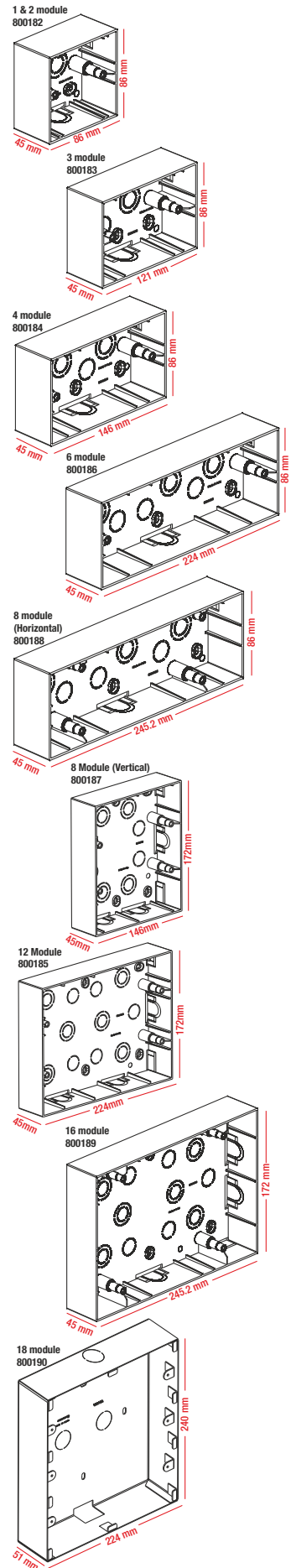

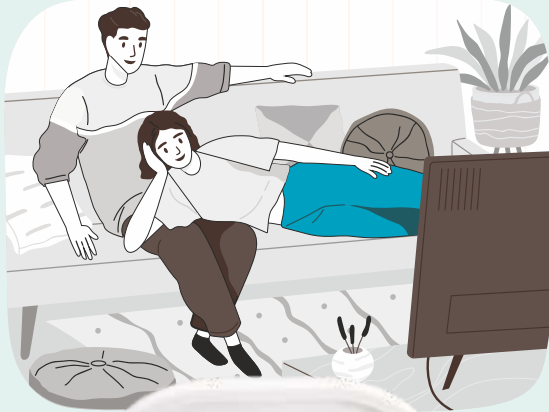

## WHITE MATTE FINISH WITH AN AESTHETIC DESIGN THAT ALLOWS EASY GRIP



White matte finish



Value for money



6A & 16A



Tested as per  
IS 1293

# PLUGS

## GENERAL TERMS

- This price list supersedes all previous price lists.
- All prices are in Indian Rupees only.
- All prices are Maximum Retail Prices (MRP) inclusive of GST as applicable.
- Our discount structure is exclusive of GST
- Orders will be accepted in multiples of standard packing.
- Prices are subject to change without notice. All despatches will be as per prices prevailing on the date of despatch. Prices are ex-godown, exclusive of packing/forwarding/freight and insurance.
- Product design is subject to change without notice for continuous up gradation.
- Disputes if any are subject to Delhi Jurisdiction only.
- Company reserves the right to issue amendments which may arise due to any printing errors in the price list.

## WARRANTY

IA products carry a warranty against manufacturing defects, subject to use of the product for the right application, with correct wiring/connection and normal operating conditions. Please refer to detailed IndoAsian warranty policy effective 1<sup>st</sup> Jan 2016.

MCBs	36 Months
RCCBs	36 Months
DBs/ACCL	12 Months
Rewirable/HRC Fuses	6 Months
MCCBs/BFF/Fuse Bases/Changeover Switchgears/SDF	12 Months
Time Switches	12 Months
For Wiring Devices - Switches & Socket	120 Months
For Wiring Devices - Electronic Products (e.g. Fan Regulator, Dimmer, Buzzer, RJ45, RJ11 & TV Sockets, Bell Indicator, Motor starter, Skirting light)	24 Months

## CHANNEL PARTNER



**CORPORATE OFFICE:** V. J. Business Towers, A-6, 1st Floor, Sector-125, Noida-201301, U.P., India. Ph.: +91-0120-3305111 E-mail: customer.care@indoasian.com, international@indoasian.com Website: www.indoasian.com

**CUSTOMER CARE HEAD:** Novateur Electrical & Digital Systems Pvt. Ltd., V. J. Business Towers, A-6, 1st Floor, Sector-125, Noida-201301, U.P., India.  
Ph.: +91-0120-3305100 Toll Free no. 1800 103 7077 E-mail: customer.care@indoasian.com

### NORTH

**Regional Sales office  
DELHI NCR**

V. J. Business Towers  
A-6, Ground Floor,  
Sector-125, Noida-201303  
Ph.: 0120-6658900

**Branch office  
CHANDIGARH**

S.C.O.: 11, 2nd Floor,  
Sector-26, Madhya Marg,  
Chandigarh-160002  
Ph.: 0172-3934651

**Branch office  
JAIPUR**

433, 4th Floor, Ganpati Plaza,  
M. I. Road,  
Jaipur-302001  
Ph.: 0141-4113528

**Branch office  
LUCKNOW**

301, 3rd Floor, Chintel House,  
Station Road,  
Lucknow-226001  
Ph.: 0522-4013210

### SOUTH

**Regional Sales office  
BANGALORE**

787, 1st Floor "Skyline Vista"  
15th Cross, 100 Feet Ring Road  
J P Nagar 1st Phase  
Bangalore-560 078  
Tel: 080-46219999

**Branch office  
COCHIN**

Door No.85/1317, Syda Building,  
2nd Floor, Kaloor-Kadavanthra Road,  
Kaloor, Ernakulam District,  
Kochi-682017 (Kerala)  
Ph.: 0484-4055581-88

**Branch office  
COIMBATORE**

Door No. 83,  
Dr. Nanjappa Road,  
Coimbatore-641018  
Ph.: 0422-2302715

**Branch office  
CHENNAI**

No.5, 1st Floor, Mahalingapuram Main Road,  
Nungambakkam,  
Chennai-600034  
Ph.: 044-28172096, 28170527

**Branch office  
HYDERABAD**

312, 3rd Floor,  
Amrutha Estates, Himayath Nagar,  
Hyderabad-500029  
Ph.: 040-66742425

### WEST

**Regional Sales office  
MUMBAI**

401 & 408, K.P. Arrum,  
Marol Morshi Road, Andheri East,  
Mumbai-400059  
Ph.: 022-61035800

**Branch office  
AHMEDABAD**

102, 1st Floor, Shivalik High Street,  
Near Mansi Circle, Vastrapur,  
Ahmedabad-380015  
Ph.: 079-29701351-53

**Branch office  
INDORE**

202, KK Bafna Arcade,  
Janjeerwala Square,  
Race Course Road,  
Indore-452001  
Ph.: 0731-4064064

**Branch office  
PUNE**

311, Pride Silicon Plaza,  
Bhamburda, Shivaji Nagar,  
Senapati Bapat Marg,  
Pune-411016  
Ph.: 8087610722

### EAST

**Regional Sales office  
KOLKATA**

"Raikva Building" Room No. 8, 2nd Floor,  
3A Ram Mohan Garden Lane,  
Beliaghata E.M.Bypass, Kolkata-700010  
Ph.: 033-66041503